



COLLECTION

2018

 **cybex**
PLATINUM



CONTENTS

4

**PRIAM
PORTFOLIO**
Individualised
Mobility

14

**MIOS
PORTFOLIO**
The New
Lightness

22

**YEMA
PORTFOLIO**
Carry On!

30

KOI
Fashion Collection

32

BIRDS OF PARADISE
Fashion Collection

34

BUTTERFLY
Fashion Collection

36

**CYBEX BY
ANNA K**

38

**CYBEX BY
JEREMY SCOTT**

40

**CYBEX BY
MARCEL WANDERS**

48

**ATON Q &
ATON Q i-SIZE**

52

CLOUD Q

54

**SIRONA &
SIRONA Q i-SIZE**

58

**SOLUTION
Q3-FIX**

60

ACCESSORIES

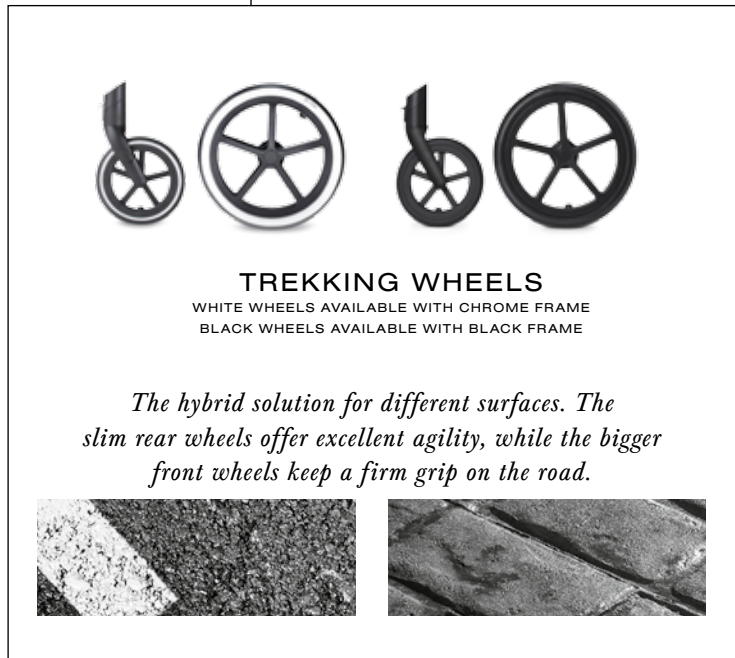
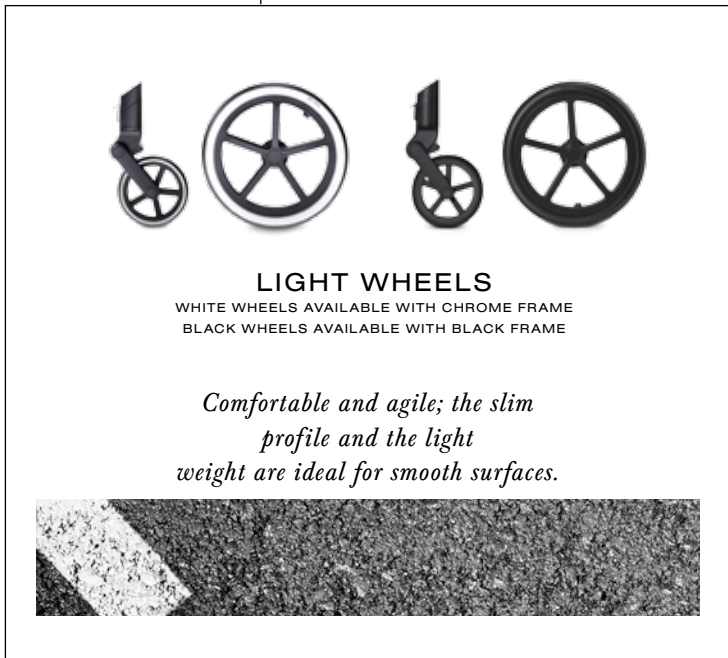
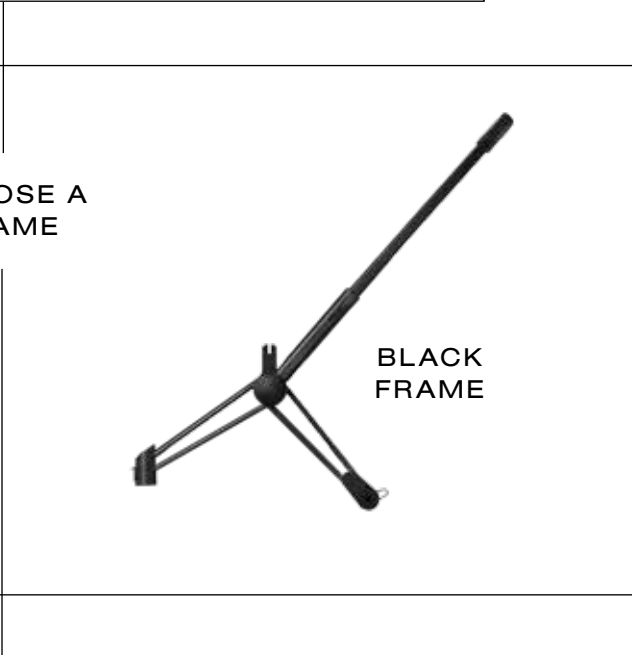
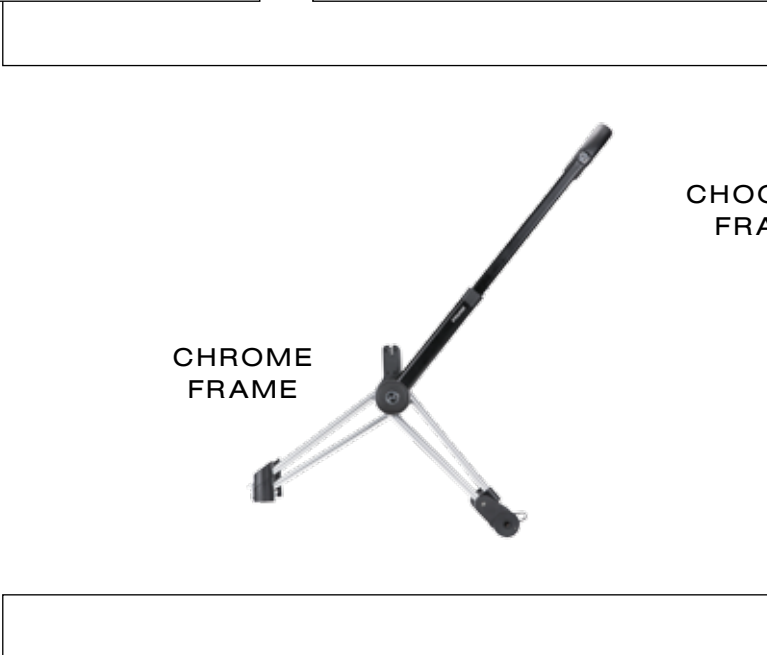

CHOOSE
A SEAT UNIT



LUX SEAT



2-IN-1 LIGHT SEAT

CYBEX PRIAM

INDIVIDUALISED
MOBILITY

The requirements of a stroller and travel system are as diverse as life itself. Because when you're out and about with children, things don't always go according to plan. The PRIAM is an ideal companion because it meets all requirements right from the start. Whether baby or infant, Light or Lux version, you'll find the right attachment for every age and every need. Regardless of which choice you make – or if the choice changes – everything will still fit on the lightweight, classic frame (available in chrome or black). The CYBEX travel system is also fully compatible with CYBEX infant car seats such as the Aton Q, Aton Q i-Size and Cloud Q.

There is also a choice of wheels for every path: Light Wheels for smooth asphalt, All Terrain Wheels for bumpy cobbles, and, as a hybrid solution, Trekking Wheels for both the city and the countryside. The PRIAM also provides a ski attachment for snow and ice and a Kid Board for siblings, both available as additional accessories. Parents of young children have enough to think about – luckily the PRIAM system offers a simple and practical solution to give peace of mind.



ALL TERRAIN WHEELS
WHITE WHEELS AVAILABLE WITH CHROME FRAME
BLACK WHEELS AVAILABLE WITH BLACK FRAME

*A smooth and comfortable ride, even on bumpy surfaces.
The big, wide wheels provide extra suspension and are suitable
for cities with cobbled streets or for trips to the countryside.*

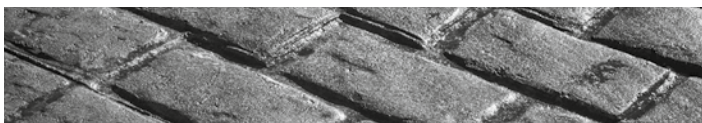



PRIAM FRAME

PRIAM's classic, simple frame is available in black and chrome, and offers a variety of individual configurations and equipment options.



BLACK FRAME

**HEIGHT-ADJUSTABLE
HANDLE BAR**
*Made from high-quality
leather-like material*

**ONE-HAND
FOLD**
*Transforms into a compact
self-standing package*

**LIGHT ALUMINIUM
FRAME**
*Stable, light and
easy to handle*

**SHOPPING
BASKET**
*Extra-large and
expandable*

**SOFT
SUSPENSION**
On front and back wheels

**HIGH-QUALITY
RUBBER WHEELS**
*Puncture-proof thanks
to foam filling*

FOOT BRAKE
Easy to use

CHROME FRAME

PRIAM WHEELS

Light Wheels, extra light for maximum mobility on smooth surfaces,
All Terrain Wheels for bumpy cobbles and trips to the countryside, and, as a hybrid solution,
Trekking Wheels for both the city and the countryside.



Frame includes Light Wheels (CL)

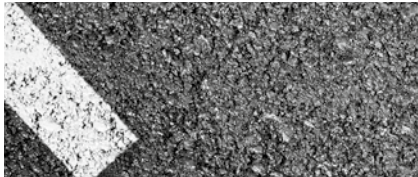

**WHITE WHEELS
WITH CHROME FRAME**
516212011

**BLACK WHEELS
WITH BLACK FRAME**
516212017



Frame includes Trekking Wheels (TK)

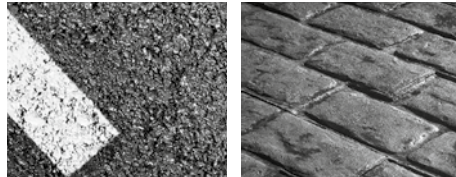

**WHITE WHEELS
WITH CHROME FRAME**
516212013

**BLACK WHEELS
WITH BLACK FRAME**
516212019



Frame includes All Terrain Wheels (AT)

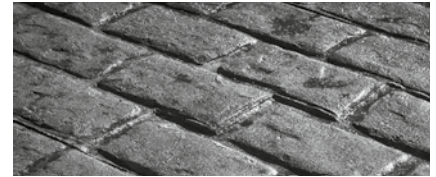

**WHITE WHEELS
WITH CHROME FRAME**
516212015

**BLACK WHEELS
WITH BLACK FRAME**
516212003

FRONT WHEEL ADAPTER FOR ROUGH TERRAIN

Front wheel adapter and Rear Wheel Set available as accessories



INFORMATION: measurements of PRIAM frame folded in mm (incl.wheels): CL + TK: L 300 x W 575 x H 950;
AT: L 300 x W 590 x H 950; weight of frame, basket and CL: 7.6 kg; TK: 7.9 kg; AT: 8.3 kg

PRIAM CARRY COT

From birth up to 9 kg (approx. 6 months)



**EXTENDABLE
XXL SUN CANOPY**
With UPF50+ sun protection

COSY FABRICS
*High-quality fabrics
in a denim look*

**PRACTICAL
DETACHABLE
CARRY HANDLE**
*Made from high-quality
leather-like material
(included in package)*

**EXTRA SOFT
MATTRESS**
With memory foam



**MANHATTAN
GREY**
517000251



**CASHMERE
BEIGE**
517000245

FABRICS

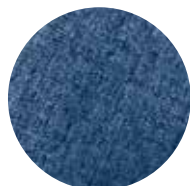

The unique denim look of the PRIAM is achieved with an exclusive and extremely hardwearing fabric with twill effect.



**MIDNIGHT
BLUE**
517000249



**STARDUST
BLACK**
517000243



AUTUMN GOLD
517000253

INFORMATION: measurements of PRIAM Carry Cot in mm: L 890 x W 450 x H 630 (unfolded canopy); L 890 x W 450 x H 240 (folded canopy); weight of PRIAM Carry Cot: 4.8kg

PRIAM LUX SEAT

From birth up to 17 kg (approx. 4 years)



**EXTENDABLE XXL
SUN CANOPY**

With UPF50+ sun protection

**COMFORTABLE
SEAT INLAY**

*Offers convenient support
and comfort*

BUMPER BAR

*Made from high-quality
leather-like material, can be
opened at either side and
rotated for easy entrance*

**HIGHCHAIR
FUNCTION**

*The seat is perfectly
aligned with
typical table heights*

LEG REST

*Individually adjustable to
three positions*

RECLINE FUNCTION

*Can be reclined into four positions,
including completely flat,
using only one hand
(for use from birth)*

**PADDED
HARNESS**

*Soft and cosy
for extra comfort*

**REVERSIBLE
SEAT**

*Can be installed to face
forward or rearward*





**MANHATTAN
GREY**
517000237



**CASHMERE
BEIGE**
517000231

FABRICS

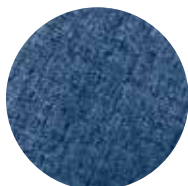

The unique denim look of the PRIAM is achieved with an exclusive and extremely hardwearing fabric with twill effect.



**MIDNIGHT
BLUE**
517000235



**STARDUST
BLACK**
517000229



AUTUMN GOLD
517000239

INFORMATION: measurements of frame with PRIAM Lux Seat folded in mm (including wheels):
CL+TK: L 420 x W 575 x H 950; AT: L 420 x W 590 x H 950; weight of PRIAM Lux Seat: 4.9 kg

PRIAM 2-IN-1 LIGHT SEAT

From 6 months up to 17 kg (approx. 4 years)



**EXTENDABLE XXL
SUN CANOPY**
With UPF50+ sun protection

BUMPER BAR
*Made from high-quality leather-like
material, can be opened at either side
and rotated for easy entrance*

**HIGHCHAIR
FUNCTION**
*The seat is perfectly aligned with
typical table heights*

**RECLINABLE
SEAT**
*Can be reclined into three
positions, using only one hand*

**REVERSIBLE
SEAT**
*Can be installed to face
forward or rearward*

**COMFORTABLE
SEAT COVER**
*Extra soft padding
and durable*

2-IN-1 SYSTEM
*The 2-in-1 system
can be easily converted into
a Carry Cot (included) and
used from birth*



AUTUMN GOLD
516213049



HAPPY BLACK
516213001



MANHATTAN GREY
516213009

FABRICS

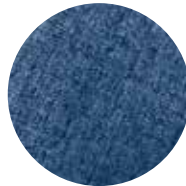

The unique denim look of the PRIAM is achieved with an exclusive and extremely hardwearing fabric with twill effect.

INFORMATION: measurements of frame with PRIAM 2-in-1 Light Seat folded in mm (including wheels):
CL+TK: L 390 x W 575 x H 1220; AT: L 420 x W 590 x H 1220; weight of PRIAM 2-in-1 Light Seat: 3.6 kg



SUN CANOPY AND HEAD CUSHION



MIOS COT

CYBEX MIOS

THE NEW LIGHTNESS

A new tribute to the innovative life's work of Charles and Ray Eames, the MIOS supports their motto: Design should not only have functionality, it must also be fun! This little brother of the PRIAM provides maximum stability in a lightweight frame, offering an airy, floating appearance. The retro-modern seat design features breathable mesh to not only support the »lightweight« aspect, but also help to regulate the child's body temperature. The narrow design glides through the urban bustle with ease. Compact, flexible, functional, and stylish – ideally suited to the needs of modern parents.



reddot award 2017
best of the best



GERMAN
DESIGN
AWARD
WINNER
2018

CHOOSE AN
INFANT CAR SEAT



ATON Q
ATON Q i-SIZE



CLOUD Q

CHOOSE A
FRAME



SEAT UNIT WITH CHROME FRAME
+ "WHITE" WHEELS



SEAT UNIT WITH BLACK FRAME
+ "BLACK" WHEELS

*Comfortable and agile; slim profile
and the light weight
are ideal for smooth surfaces.*



MIOS FRAME

The MIOS frame is available in chrome incl. white wheels or in black incl. black wheels



BLACK FRAME INCLUDING SEAT UNIT
517001379

ONE-HAND FOLD
Transforms it into a compact stand-alone package

HEIGHT-ADJUSTABLE HANDLE BAR
In premium leather look

LIGHT ALUMINIUM FRAME
Stable, light, and easy to use

FOOT BRAKE
Easy to use

FRONT SWIVEL WHEELS
Can be locked for stability on uneven surfaces

SHOPPING BASKET
To store your belongings (max. load 5 kg)

PUNCTURE-PROOF WHEELS
Profiled wheels for more grip

SOFT SUSPENSION
Front and back wheels

CHROME FRAME INCLUDING SEAT UNIT
517001377



**SUPER
COMPACT FOLD**
Self-standing

**COMPACT FOOTPRINT
OF 50 CM**
Perfect for narrow streets
and public transport

**ALL-WHEEL
SUSPENSION**
For a smooth ride

INFORMATION: measurements of folded MIOS frame in mm (including wheels):
L 330 x W 500 x H 750; weight of frame: 4.3 kg

MIOS COT

From birth up to 9 kg (approx. 6 months)





**MANHATTAN
GREY**
517000807



**CASHMERE
BEIGE**
517000801



MIDNIGHT BLUE
517000805



**STARDUST
BLACK**
517000799



AUTUMN GOLD
517000809

INFORMATION: measurements of MIOS Cot in mm: L 840 x W 420 x H 550 (unfolded canopy);
L 840 x W 420 x H 210 (folded canopy); weight of Mios Cot: 4.1 kg



MIOS SEAT UNIT

From birth up to 17 kg (approx. 4 years)



RECLINE FUNCTION
Can be reclined to a completely flat position with one hand

EXTENDABLE XXL SUN CANOPY
With UPF50+ sun protection and viewing window (sold separately as colour pack)

BUMPER BAR
Made from high-quality leather-like material, can be opened at either side for easy entrance

LEG REST
Individually adjustable to multiple positions

MEMORY BUTTONS
Seat unit can be clicked on and off with ease

HEAD CUSHION
Soft and comfy for extra comfort (sold separately as colour pack)

REVERSIBLE SEAT UNIT
Can be installed to face forward or rearward

PADDED HARNESS
Soft and cosy for extra comfort

MESH SEAT BACK
Light and breathable



COMFORT INLAY
Comfy on both warm and cold days (see accessories)





**MANHATTAN
GREY**
517001390



**CASHMERE
BEIGE**
517001384

COLOUR PACK

(contains sun canopy and head cushion)



MIDNIGHT BLUE
517001388



**STARDUST
BLACK**
517001382



AUTUMN GOLD
517001392

INFORMATION: measurements of MIOS Seat Unit on frame in mm (including wheels): L 830-940 x W 500 x H 980-1080;
weight of frame + basket + seat (incl. wheels): 8.7 kg





YEMA

A familiar voice, cosy warmth and that unique smell – a baby carrier intensifies that important bond between parent and child from birth. »Babywearing« nurtures a deep sense of trust between parent and infant, while stimulating the child's cognitive development. The correct carrying method places the infant in the healthy spread-squat position, helping the joints to develop. A baby carrier provides you with almost unlimited mobility: while your baby is in a snug and safe place, your hands are free to deal with the challenges of fast, urban life. The YEMA is now available in 2 versions: YEMA TIE for easy individual adjustment and YEMA CLICK for fast click-on & click-off - perfectly fitting to your personal needs.



CARRY POSITIONS

From newborn to toddler (approx. 3.5 - 15 kg)
with three carrying positions: in front, on the side or on the back

YEMA CLICK



FRONT
CARRYING

Babies can be carried facing the chest from birth. The baby carrier encourages the correct posture in the spread-squat position, which can help the hip joints to develop correctly.



HIP
CARRYING

Babies that can hold their own head (from around 3-4 months) can also be carried in the side position. This allows them to rest against mum's shoulder while taking in their surroundings.



BACK
CARRYING



YEMA TIE



FRONT
CARRYING



HIP
CARRYING



BACK
CARRYING



FUNCTIONS

The YEMA TIE from the CYBEX Platinum range is a new generation of fashionable baby carrier, expertly combining ergonomics and comfort with quality you can count on. The carrier's easy and intuitive tying function ensures a perfect fit for parents of all sizes.

**MULTIFUNCTIONAL
HEAD AND NECK
SUPPORT**

For babies of every size

**COMFORTABLY
PADDED SHOULDER
STRAPS**

*With optional crossed or
parallel function*

**100% WRAP-LIKE
COTTON FABRIC**

*To fit different sized children
and offer optimum support*

**ERGONOMIC
SEATING**

*With adjustable panel width
inside the waist belt*

**ICONIC AND
DECORATIVE
WINGS**

**SOFT PADDED
WAIST BELT**

*For long-wearing comfort
with security loop*

**TIE'S
SPECIAL**

*Easy and intuitive fit
for parents of all
sizes*



YEMATIE



**DENIM
STARDUST BLACK**
517000404



**DENIM
MIDNIGHT BLUE**
517000406

FABRICS



**DENIM
MANHATTAN GREY**
517000408



**LEATHER-LOOK
STARDUST BLACK**
517000963



FUNCTIONS

The YEMA CLICK is a new generation of fashionable baby carrier, expertly combining ergonomics and comfort with quality you can count on. The carrier's smart click-on and click-off system ensures easy and fast handling.

**MULTIFUNCTIONAL
HEAD AND NECK
SUPPORT**

For babies of every size

**COMFORTABLY
PADDED SHOULDER
STRAPS**

*With optional crossed or
parallel function*

**100% WRAP-LIKE
COTTON FABRIC**

*To fit different sized children
and offer optimum support*

**ERGONOMIC
SEATING**

*With adjustable panel width
inside the waist belt*

**ICONIC AND
DECORATIVE
WINGS**

**SOFT PADDED
WAIST BELT**

*For long-wearing comfort
with security loop*

**CLICK'S
SPECIAL**

*Easy & fast
click-on and
click-off system*

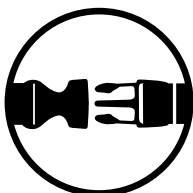

YEMIA CLICK



**DENIM
STARDUST BLACK**
518000658



**DENIM
MIDNIGHT BLUE**
518000660

FABRICS



**DENIM
MANHATTAN GREY**
518000662



**LEATHER-LOOK
STARDUST BLACK**
518000655



KOI FASHION COLLECTION



Crystallized. Calmness. Strength and happiness. The new CYBEX Fashion Collection KOI blends the symbolism of the enigmatic underwater creature of Japanese mythology with state-of-the-art technology, materials and tailoring. Just like the underwater jewel itself, modern and fashion-conscious parents can go with the flow of the metropolis thanks to CYBEX »KOI«. Premium appliqués and embroidery on a unique reflecting, crystal-silver material, harmonise perfectly with all major Prêt-à-Porter lines. The new PRIAM, MIOS, Cloud Q, YEMA TIE and matching accessories bring this colourful aquatic animal to life, while helping little ones drift off into fanciful dreams.



**CLOUD Q
(SHOWN ON PRIAM FRAME)**
51800001



**PRIAM LUX SEAT
(SHOWN ON PRIAM FRAME)**
51800009



**PRIAM CARRY COT
(SHOWN ON PRIAM FRAME)**
51800019



**CLOUD Q
(SHOWN ON MIOS FRAME)**
51800001



**MIOS FASHION EDITION
KOI**
518000029



**MIOS COT
(SHOWN ON MIOS FRAME)**
518000039

TRAVEL SYSTEM KOI

The CYBEX PRIAM and MIOS Platinum 3-in-1 travel systems enable three different uses: with matching Carry Cot, with one of the award-winning CYBEX infant car seats, and later as a luxurious stroller with a reversible seat unit.



YEMA TIE KOI

518000049

From newborn to toddler (3.5 - 15kg)

The YEMA TIE is a fanciful fashion statement that expertly combines ergonomics and comfort with quality you can count on. The diagonal-elastic wrap-like fabric supports baby's head and naturally-rounded back.



CLOUD Q KOI

518000001

Gr. 0+, up to 13kg (from birth to approx. 18 months)

The Cloud Q, test winner for Group 0+ in the 06 / 2015 test conducted by German Stiftung Warentest, is now available in the »KOI« collection with premium appliqués on a unique reflecting, crystal-silver material. The infant car seat is a perfect symbiosis of safety and fashionable design.

DESIGN



**CHANGING BAG
KOI**

518000056

The stylish baby bag with silver-reflecting material comes with a changing mat, a wet compartment, multi-functional storage pockets, and even a removable clutch bag.



The premium reflecting crystal-silver fabric leads you in the mythology of Japanese enigmatic underwater creatures.



**FOOTMUFF
KOI**

518000052

The stylish footmuff with cosy fleece lining scores extra points with its »KOI« embroidery and fits perfectly in the PRIAM and MIOS strollers. Water-repellent material protects against wind, rain, and cold.



**BABY BLANKET
KOI**

518000054

The cosy blanket with crystal-silver material is perfect for keeping your baby warm and happy. The knitted blanket is easy to clean and is machine washable.

BIRDS *of* PARADISE FASHION COLLECTION



Follow nature's path. Nature springs to life in the new Birds of Paradise collection as CYBEX transports vivid and exotic wildlife into the big city.

Shimmering and colourful parrots and plants are added as elaborate embroidery to the PRIAM Lux Seat and Carry Cot, MIOS Seat Unit and Cot, Cloud Q, YEMA TIE and numerous accessories of the CYBEX Platinum Range.

Drawing inspiration from the latest catwalk trends from across the world, this new collection is the ultimate fashion statement.



CLOUD Q
(SHOWN ON PRIAM FRAME)
517000969



PRIAM LUX SEAT
(SHOWN ON PRIAM FRAME)
517000971



PRIAM CARRY COT
(SHOWN ON PRIAM FRAME)
517000973



CLOUD Q
(SHOWN ON MIOS FRAME)
517000969



MIOS FASHION EDITION
BIRDS OF PARADISE
517000977



MIOS COT
(SHOWN ON MIOS FRAME)
517000981

TRAVEL SYSTEM BIRDS OF PARADISE

The CYBEX PRIAM and MIOS Platinum 3-in-1 travel systems enable three different uses: with matching Carry Cot, with one of the award-winning CYBEX infant car seats, and later as a luxurious stroller with a reversible seat unit.



**YEMA TIE
BIRDS OF PARADISE**

517000995

From newborn to toddler (3.5 - 15 kg)

The YEMA TIE with its tropical jungle print and the parrot embroidery is a new generation of fashionable baby carrier, expertly combining ergonomics and comfort with quality you can count on.



**CLOUD Q
BIRDS OF PARADISE**

517000969

Gr. 0+, up to 13 kg (from birth to approx. 18 months)

The Cloud Q, test winner for Group 0+ in the 06/2015 test conducted by German Stiftung Warentest, is now available in the »Birds of Paradise« collection with colourful parrot embroidery. The infant car seat is a perfect symbiosis of safety and fashionable design.

DESIGN



**PARASOL
BIRDS OF PARADISE**

517001020

The parasol with »Birds of Paradise« print can be attached to the frame and offers extra shade and sun protection.



The high-quality fabric with tropical jungle print shines through the glowing parrot embroideries for a real fashion statement



**FOOTMUFF
BIRDS OF PARADISE**

517000998

The stylish footmuff with cosy fleece lining scores extra points with its »Birds of Paradise« print and parrot embroidery. It fits perfectly in the PRIAM and MIOS strollers. Water-repellent material protects against wind, rain, and cold.



**CHANGING BAG
BIRDS OF PARADISE**

517001000

The stylish baby bag in jungle print transforms into a back bag. It comes with a changing mat, a wet compartment, multi-functional storage pockets, and even a removable clutch bag.



**BABY BLANKET
BIRDS OF PARADISE**

517001002

The cosy blanket with tropical print is perfect for keeping your baby warm and happy. The blanket has soft fleece on one side and a knitted liner on the other. It is easy to clean and is machine washable.

BUTTERFLY FASHION COLLECTION

The CYBEX Butterfly Collection combines luxurious camouflage fabric with beautiful butterfly embroidery. Imagine you are at the zoo, walking by the butterfly enclosure. You can read on the sign that there are butterflies inside but it isn't as easy to spot them. Can you see them?



**CLOUD Q
(SHOWN ON PRIAM FRAME)**
516110015



**PRIAM LUX SEAT
(SHOWN ON PRIAM FRAME)**
516211015



**PRIAM CARRY COT
(SHOWN ON PRIAM FRAME)**
516210015



**CLOUD Q
(SHOWN ON MIOS FRAME)**
516110015



**MIOS FASHION EDITION
BUTTERFLY**
517000975



**MIOS COT
(SHOWN ON MIOS FRAME)**
517000979

TRAVEL SYSTEM BUTTERFLY

The CYBEX PRIAM and MIOS Platinum 3-in-1 travel systems enable three different uses: with matching Carry Cot, with one of the award-winning CYBEX infant car seats, and later as a luxurious stroller with a reversible seat unit.



**YEMA TIE
BUTTERFLY**

517000411

From newborn to toddler (3.5 - 15kg)

The YEMA TIE with its jacquard and colourful butterflies is a new generation of fashionable baby carrier, expertly combining ergonomics and comfort with quality you can count on.



CLOUD Q BUTTERFLY

516110015

Gr. 0+, up to 13kg (from birth to approx. 18 months)

The Cloud Q, test winner for Group 0+ in the 06 / 2015 test conducted by German Stiftung Warentest, is now available in the »Butterfly« collection with colourful butterfly embroidery. The infant car seat is a perfect symbiosis of safety and fashionable design.

DESIGN



**CHANGING BAG
BUTTERFLY**

516430028

The stylish baby bag in jacquard and leather look features a removable thermal bottle holder, a changing mat, a wet compartment and an exterior pocket for your mobile phone.



The high-quality, classy jacquard fabric is embellished with embroidered and laser-cut butterflies.



**FOOTMUFF
BUTTERFLY**

516430022

The stylish footmuff with cosy fleece lining scores extra points with its jacquard look covered with little butterflies. It is compatible with the PRIAM and MIOS strollers. The water-repellent material protects against wind, rain, and cold.



**BABY BLANKET
BUTTERFLY**

516430026

The cosy blanket in khaki beige with a jacquard border is perfect for keeping your baby warm and happy. The blanket has soft fleece on one side and a knitted liner on the other. It is easy to clean and is machine washable.



CYBEX x ANNA K



The sweeping expanse of the universe, where stars, planets and galaxies move beyond space and time in an everlasting dance with gravity was fashion's new shooting star Anna K's inspiration for her SPACE ROCKET collection for CYBEX. The interaction between softness and power, cocooning and exploring is reflected in the new editions of MIOS, PRIAM, YEMA TIE and CLOUD Q – intergalactic space capsules for little urban star hunters. Every walk turns into an individual orbit for metropolitans.

The countdown is on. Bon Voyage!



CLOUD Q
(SHOWN ON PRIAM FRAME)
518001555



PRIAM LUX SEAT
(SHOWN ON PRIAM FRAME)
518001377



PRIAM CARRY COT
(SHOWN ON PRIAM FRAME)
518001369



CLOUD Q
(SHOWN ON MIOS FRAME)
518001555



ANNA K MIOS
FASHION EDITION
518001385



MIOS COT
(SHOWN ON MIOS FRAME)
518001393

ANNA K TRAVEL SYSTEM

The CYBEX PRIAM and MIOS Platinum 3-in-1 travel systems enable three different uses: with matching Carry Cot, with one of the award-winning CYBEX infant car seats, and later as a luxurious stroller with a reversible seat unit.



**ANNA K
YEMA TIE**

518001405

From newborn to toddler (3.5 - 15 kg)

The YEMA TIE is an intergalactical fashion statement that expertly combines ergonomics and comfort with quality you can count on. The diagonal-elastic wrap-like fabric supports baby's head and naturally-rounded back.



ANNA K CLOUD Q

518001555

Gr. 0+, up to 13 kg (from birth to approx. 18 months)

The Cloud Q, test winner for Group 0+ in the 06 / 2015 test conducted by German Stiftung Warentest, is now available in the »Anna K« collection with space print and intergalactical appliques. The infant car seat is a perfect symbiosis of safety and fashionable design.

DESIGN



**ANNA K
CHANGING BAG**

518001428

The stylish baby bag with space print and leather-look features a removable thermal bottle holder, a changing mat and a wet compartment.



The high-quality fabric is embellished with appliques as planets, rockets and stars and takes parents and children to the sweeping expanse of the universe.



**ANNA K
FOOTMUFF**

518001424

The stylish footmuff with cosy fleece lining scores extra points with its intergalactical print. It is compatible with the PRIAM and MIOS strollers. The water-repellent material protects against wind, rain, and cold.

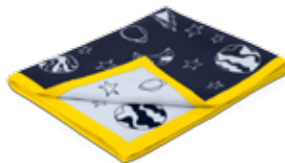

**ANNA K
BABY BLANKET**

518001432

The cosy blanket is knitted with a beautiful jacquard technique which supports the theme SPACE. It's easy to clean and machine washable.

CYBEX x JEREMY SCOTT

Renowned for challenging conventions to the core, the American designer Jeremy Scott breaks up the design customs of the fashion world, creating works of art that are visually extravagant and also functional. Having dressed various superstars such as Rihanna, Katy Perry, and Miley Cyrus, as well as a renowned collaboration with the sportswear label adidas, the Creative Director of Moschino offers a second cooperation with CYBEX.



**ATON Q (SHOWN ON PRIAM
JEREMY SCOTT FRAME)**
516105001



**JEREMY SCOTT
PRIAM LUX SEAT**
516211061



**PRIAM CARRY COT (SHOWN ON
PRIAM JEREMY SCOTT FRAME)**
516210001



**ATON Q (SHOWN ON MIOS
JEREMY SCOTT FRAME)**
516105001



**JEREMY SCOTT MIOS
FASHION EDITION**
518001321



**MIOS COT (SHOWN ON MIOS
JEREMY SCOTT FRAME)**
518001345

JEREMY SCOTT TRAVEL SYSTEM

The CYBEX PRIAM and MIOS Platinum 3-in-1 travel systems enable three different uses: with matching Carry Cot, with the award-winning Aton Q infant car seat, and later as a luxurious stroller with a reversible seat unit.



JEREMY SCOTT YEMA TIE

518000147

From newborn to toddler (3.5 - 15 kg)

The YEMA TIE from the CYBEX by Jeremy Scott Capsule Collection is a new generation of fashionable baby carrier, expertly combining ergonomics and comfort with quality you can count on. With its golden wings your little angel will be carried in style!



JEREMY SCOTT ATON Q

516105001

Gr. 0+, up to 13 kg (from birth to approx. 18 months)

The award-winning Aton Q, is available in the Jeremy Scott »Capsule Collection«. The infant car seat is a perfect symbiosis of safety and fashionable design and completes your Jeremy Scott 3-in-1 travel system.

DESIGN



The smart colour combination of black with gold details give the Jeremy Scott "Capsule Collection" extra sparkle and the little ones wings.



JEREMY SCOTT CHANGING BAG

516430008

Black and adorned with gold details, the useful CYBEX changing bag by Jeremy Scott comes with a wet compartment, bottle holder, changing mat, and additional outside pocket with a beautiful wing-shaped gold zipper pull.



JEREMY SCOTT FOOTMUFF

516430024

The CYBEX footmuff by Jeremy Scott offers protection against wind, rain, and cold. Made from easy-care fabrics with a cosy lining, this spacious footmuff has a plastic insert to prevent soiling from shoes.

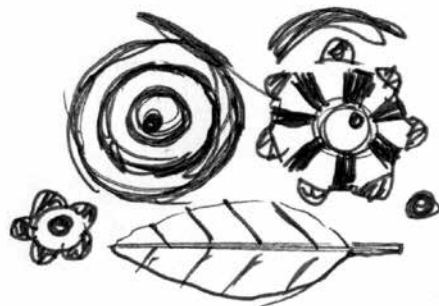

LIVING YOUR MOST FABULOUS DREAM

For the first time, CYBEX is connecting with the world of interior design. With the launch of a furniture line and a colourful accessory line that includes a highchair, everything is redesigned to fit seamlessly into the parents' lifestyle. Leading this exciting collection is the internationally celebrated product and interior designer, Moooi owner, and industry rebel Marcel Wanders. The »Parent's Collection« is sophisticated yet playful, allowing parents to continue their cultivated lives – even with little ones in tow. To go one step further, the new range also lets mums and dads pass on their creativity to the next generation through design-forward furniture that smoothly integrates, creating a dream environment in the home.





HIGHCHAIR

BY MARCEL WANDERS

Make every meal memorable with our iconic wooden highchair, exquisitely designed for comfort and style. Suitable from 6 months up to 3 years (15 kg), the chair is easily adaptable and features a removable snack and play tray, a harness system, safety bar and the footrest can be adjusted to the preferred height so your little one will always be comfortable. This outstanding highchair is made from a beech wood frame, chrome-plated steel parts along with an ergonomic, durable plastic seat shell which supports a luxurious cushion that is lavishly embroidered and attached on the back with an iconic flower screw. Who knew mealtimes could be so stylish?



HIPPIE WRESTLER
517000261



GRAFFITI
517000259



LOVE GURU
517000257



SPACE PILOT
517000263

INFORMATION: measurements in mm: L 520 x W 550 x H 850; seat height: 570

BOUNCER

BY MARCEL WANDERS

This chic bouncer is the perfect multi-tasker, great for bouncing, playing or drifting off to sleep. Suitable from birth up to 15 kg (approx. 3 years), it has the distinctive appearance of this global designer, and is made using top quality materials, chrome-plated steel parts and beech wood. It isn't just a style piece though, the bouncer is practical too. With a 3-point harness attachment, your little one can bounce independently and safely, plus you can adjust it to two positions. To top it off, the iconic flower screw makes the collection a stylish must-have for any home. The sun canopy accessory is perfect for days of bouncing fun outside on the terrace.



SUN CANOPY
(AVAILABLE AS ACCESSORY)
517000293



HIPPIE WRESTLER
517000269



GRAFFITI
517000267



LOVE GURU
517000265



SPACE PILOT
517000271



INFORMATION: measurements in mm:

upright position: L 570 x W 500 x H 550; reclining position: L 570 x W 500 x H 390

ROCKER

BY MARCEL WANDERS

Enjoy moments of bliss with your child as they relax in the Rocker. The baby rocker, featuring a swing function, is Marcel Wanders' modern interpretation of the classic rocking chair. Suitable from birth to a weight of 15kg (about 3 years) the Rocker is made from high-quality materials such as decorative beech wood and a classy chrome-plated steel frame. The elaborately embroidered cushion, coupled with the iconic flower-shaped screw on the back, is not only a calm oasis for the kids, but also a real design object for the home. What is more, the 3-point harness and the anti-slip feature ensure that the child can safely swing in the house or, on a warm day, on the terrace.



SUN CANOPY
(AVAILABLE AS ACCESSORY)
517000293



HIPPIE WRESTLER
517000277



GRAFFITI
517000275



LOVE GURU
517000273



SPACE PILOT
517000279

INFORMATION: measurements in mm:
L 720 x W 430 x H 380

HAUSSCHWEIN

BY MARCEL WANDERS

Let your little one enter a fairy-tale world with this delightful companion, a storage piggy! Great as an extra storage space for all ages, simply remove the nose and store toys or games inside. With a quilted pattern on its hindquarters and available in a sleek matte black or white finish, this endearing piggy is a charming and stylish addition to any home.



HAUSSCHWEIN BLACK
517000281



HAUSSCHWEIN WHITE
517000283



reddot award 2016
winner

INFORMATION: measurements in mm: L 745 × W 338 × H 401

MONSTER TOYS

BY MARCEL WANDERS

Inspired by the charming embroidery on the highchair, our hand puppet collectibles are fun for the whole family. Each of the four characters has a unique appearance and story, so your little one's imagination can run wild. Check out their wonderful expressions, each one more special and colourful than the last! Delight your baby with these mini cuddle toys and let the dreams begin.



GRAFFITI
517000288



HIPPIE WRESTLER
517000290



SPACE PILOT
517000292



LOVE GURU
517000286

INFORMATION: measurements in mm: L 010 x W 210 x H 213

A PERFECT FAMILY

Outstanding safety and quality, contemporary
design and intelligent functionality:
the CYBEX PLATINUM child car seats.





ATON Q

Gr. 0+, up to 13 kg (from birth to approx. 18 months)



**INTEGRATED
XXL FOLD AWAY
SUN CANOPY**
*Perfect sun and wind
protection with UPF50+*

**8-POSITION
HEIGHT-ADJUSTABLE
HEADREST**
*With integrated harness
guide for protection
that grows with the child*

**EXTRA WIDE
Y-HARNESS**
*With a soft belt and
crotch pads*

**REMOVABLE
SEAT INSERT**
*Ensures a near flat-lying position,
reducing the risk of the head
falling forward while asleep*

**TELESCOPIC
L.S.P. SYSTEM**
*The telescopic Linear
Side-impact Protection reduces
the force of a side-impact
collision in combination with the
energy absorbing shell*

**ENERGY-
ABSORBING SHELL**
*The flexible structure of the
material reduces the forces of a side-
impact collision and protects the baby*



BASE Q-FIX

*The troublesome installation of the
car seat is no longer complicated*

ISOFIX
Extra stability and safety

**QUICK BELT
TENSIONING DEVICE**
*When used in
cars without ISOFIX*

BASE Q-FIX
515141002

**HEIGHT-
ADJUSTABLE
LOAD LEG**
Enhanced stability



ATON Q

The soft comfort version of the Aton Q collection is available in four colour combinations.



STARDUST BLACK
517000002



MIDNIGHT BLUE
517000006



GRAPHITE BLACK
517000008



AUTUMN GOLD
517000010



reddot award 2014
winner

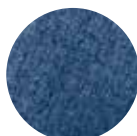

ATON Q PLUS

The Aton Q Plus collection gets its characteristic denim look from our exclusive and hardwearing twill effect fabric. It is available in four different colour combinations.



STARDUST BLACK
517000014



MIDNIGHT BLUE
517000020



MANHATTAN GREY
517000022



AUTUMN GOLD
517000024

INFORMATION: measurements in mm: L 650 x W 440 x H 390-560; weight: 4.6kg

ATON Q i-SIZE

ECE R-129, 45 cm - 75 cm, max. 13 kg



**INTEGRATED
XXL FOLD AWAY
SUN CANOPY**
*Perfect sun and wind
protection with UPF50+*

**8-POSITION
HEIGHT-ADJUSTABLE
HEADREST**

*With integrated harness
guide for protection
that grows with the child*

**EXTRA WIDE
Y-HARNESS**

*With a soft belt and
crotch pads*

**REMOVABLE
SEAT INSERT FOR
NEWBORNS**

*Ensures a near flat-lying position,
reducing the risk of the head
falling forward while asleep
(up to the age of 3 months)*

**TELESCOPIC
L.S.P. SYSTEM**

*The telescopic Linear
Side-impact Protection reduces
the force of a side-impact
collision in combination with the
energy absorbing shell*

**ENERGY-
ABSORBING SHELL**

*The flexible structure of the
material reduces the forces of a side-
impact collision and protects the baby*

BASE Q i-SIZE

*The troublesome installation of the
car seat is no longer complicated*

ISOFIX
Extra stability and safety



**HEIGHT-
ADJUSTABLE
LOAD LEG**
Enhanced stability

BASE Q i-SIZE
516410002

ATON Q i-SIZE

The soft comfort version of the Aton Q i-Size collection is available in four colour combinations.



STARDUST BLACK
517000028



MIDNIGHT BLUE
517000030



GRAPHITE BLACK
518000152



AUTUMN GOLD
517001330

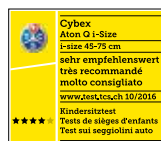
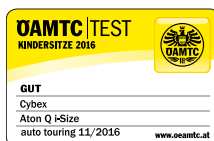

ATON Q i-SIZE PLUS

The Aton Q i-Size Plus collection gets its characteristic denim look from our exclusive and hard-wearing twill effect fabric. It is available in four different colour combinations.



STARDUST BLACK
518000156



MIDNIGHT BLUE
518000158



MANHATTAN GREY
518000160



AUTUMN GOLD
518000162

INFORMATION: measurements in mm: L 650 x W 440 x H 390-560; weight: 4.9kg

CLOUD Q

Gr. 0+, up to 13 kg (from birth to approx. 18 months)



RECLINING BACKREST

Ergonomic lie-flat position outside the car

11-POSITION HEIGHT-ADJUSTABLE HEADREST

With integrated harness guide for protection that grows with the child

EXTRA WIDE Y-HARNESS

With a soft belt and crotch pads

REMOVABLE NEWBORN INLAY

Ensures a near flat-lying position and can reduce the risk of the head falling forward while asleep

INTEGRATED XXL FOLD AWAY SUN CANOPY

Perfect sun and wind protection with UPF50+

TELESCOPIC L.S.P. SYSTEM

The telescopic Linear Side-impact Protection reduces the force of a side-impact collision in combination with the energy absorbing shell

ENERGY-ABSORBING SHELL

The flexible structure of the material absorbs the forces of a side-impact collision and protects the baby



BASE Q-FIX

The troublesome installation of the car seat is no longer complicated

ISOFIX

Extra stability and safety

QUICK BELT TENSIONING DEVICE

When used in cars without ISOFIX



BASE Q-FIX
515141002

HEIGHT-ADJUSTABLE LOAD LEG

Enhanced stability

CLOUD Q

The padded comfort version of the Cloud Q collection is available in four colour combinations.



**STARDUST
BLACK**
517000032



**MIDNIGHT
BLUE**
517000036



**GRAPHITE
BLACK**
517000038



**AUTUMN
GOLD**
517000040

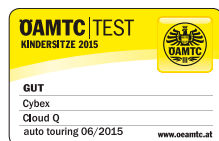

reddot award 2016
winner

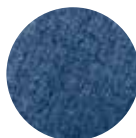

CLOUD Q PLUS

The Cloud Q Plus gets its characteristic denim look from our exclusive and hard-wearing twill effect fabric. It is available in four different colour combinations.



**STARDUST
BLACK**
517000044



**MIDNIGHT
BLUE**
517000050



**MANHATTAN
GREY**
517000052



**AUTUMN
GOLD**
517000054

INFORMATION: measurements in mm: L 670 x W 440 x H 395 - 565; weight: 5.4 kg

SIRONA

Gr. 0+/1, up to 18 kg (from birth up to approx. 4 years)



360° ROTATION
Allows for an easy change between rear and forward-facing, as well as a comfortable entry and exit position

DEPTH-ADJUSTABLE IMPACT SHIELD
When used front-facing (9 – 18 kg, approx. 9 months up to 4 years)



SIRONA

The soft comfort version of the Sirona collection is available in four colour combinations.



**STARDUST
BLACK**

517000057



**MIDNIGHT
BLUE**

517000061



**GRAPHITE
BLACK**

517000063



**AUTUMN
GOLD**

517000065



reddot design award
winner 2012

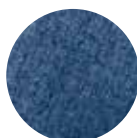

SIRONA PLUS

The Sirona Plus collection gets its unique appearance from an exclusive, very hard-wearing fabric with a twill effect and a denim look. It is available in four different colour combinations.



**STARDUST
BLACK**

517000069



**MIDNIGHT
BLUE**

517000075



**MANHATTAN
GREY**

517000077



**AUTUMN
GOLD**

517000079

INFORMATION: measurements in mm: L 680 x W 440 x H 635; weight: 15kg

SIRONA Qi-SIZE

ECE R-129, 45 cm - 105 cm, max. 18 kg



12-POSITION HEIGHT-ADJUSTABLE HEADREST

Simple and quick adjustment for a perfect fit

CENTRAL ONE-PULL HARNESS SYSTEM

Comfortable and safe fastening

ONE-HAND RECLINING FUNCTION

For an excellent sleep and a relaxed journey

REBOUND BAR

For maximum protection in the event of a rear collision (when used rear-facing)

ONE-CLICK INSTALLATION WITH ISOFIX

Increased safety and simple installation that requires no additional fastening

TELESCOPIC L.S.P. SYSTEM

The telescopic Linear Side-impact Protection reduces the force of a side-impact collision in combination with the head and shoulder protectors (patent pending)

MAGNETIC BELT HOLDER

For easy boarding



SIRONA Q i-SIZE

The soft comfort version of the Sirona Q i-Size collection is available in three colour combinations.



**STARDUST
BLACK**
517000641



**MIDNIGHT
BLUE**
517000645



**AUTUMN
GOLD**
517000649

SPECIAL

360° ROTATION

Allows an easy change between rear and forward-facing, as well as a comfortable entry and exit position



**DEPTH-ADJUSTABLE
IMPACT SHIELD**

When used front-facing (from min. 16 months and 76 cm)



INFORMATION: measurements in mm: L 710 x W 440 x H 635; weight: 15 kg

SOLUTION Q3-FIX

Gr. 2/3, 15 – 36 kg (approx. 3 to 12 years)



3-POSITION RECLINING HEADREST

The CYBEX patented 3-position reclining headrest shifts the balance point of the child's head slightly back and prevents the head from falling forward when the child is asleep. In the event of a side-impact collision, the child's

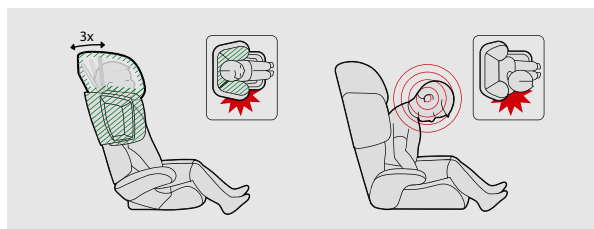

head remains within the safety zone of the seat, ensuring maximum protection. The patented head protection ensures a more comfortable sleeping position and enhanced safety compared to conventional systems.

SOLUTION Q3-FIX

The soft comfort version of the Solution Q3-Fix collection is available in four colour combinations.



**STARDUST
BLACK**
517000084



**MIDNIGHT
BLUE**
517000088



**GRAPHITE
BLACK**
517000090



**AUTUMN
GOLD**
517000092



SOLUTION Q3-FIX PLUS

The Solution Q3-Fix Plus collection gets its unique appearance from an exclusive, very hard-wearing fabric with a twill effect in a denim look. It is available in four different colour combinations.



**STARDUST
BLACK**
517000096



**MIDNIGHT
BLUE**
517000102



**MANHATTAN
GREY**
517000104



**AUTUMN
GOLD**
517000106

INFORMATION: measurements in mm: L 405 x W 530 x H 625; weight: 7.6kg

ACCE SSO RIES



ACCESSORIES

The elegant PLATINUM Footmuff offers a comfortable and cosy fleece lining to keep your little one warm. The upper materials feature leather-look applications and match perfectly to the PRIAM and MIOS strollers fashionable design. Water-repellent materials protect from the cold, wind and rain.

PLATINUM FOOTMUFF



MANHATTAN GREY
518001442



**CASHMERE
BEIGE**
518001438



**MIDNIGHT
BLUE**
518001440

FABRICS

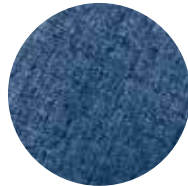

**STARDUST
BLACK**
518001436



**AUTUMN
GOLD**
518001444

CYBEX PLATINUM

The fabulous PLATINUM Changing Bags come with a removable thermal bottle holder, a changing mat and a wet compartment.

PRIAM CHANGING BAG



**STARDUST
BLACK**
517000768



**AUTUMN
GOLD**
517001780



**MANHATTAN
GREY**
517000772

MIOS CHANGING BAG



**STARDUST
BLACK**
517001782



**AUTUMN
GOLD**
517001786



**MANHATTAN
GREY**
517001784

MIOS COMFORT INLAY

Comfy on both warm and cold days.



**STARDUST
BLACK**
517001396



**CASHMERE
BEIGE**
517001398



**MIDNIGHT
BLUE**
517001402



**MANHATTAN
GREY**
517001404



**AUTUMN
GOLD**
517001406

FRONT WHEEL ADAPTER

Converts your PRIAM into a rough terrain pram.



**PRIAM FRONT WHEEL
ADAPTER
ROUGH TERRAIN**
517000856

*Our PRIAM Rear Wheel Sets can also be used as front wheels
thanks to our Front Wheel Adapter.*



**PRIAM REAR WHEEL SET
CITY LIGHT/TREKKING**
BLACK: 517001008
WHITE: 517001010



**PRIAM REAR WHEEL SET
ALL TERRAIN**
BLACK: 517001004
WHITE: 517001006



**PRIAM FRONT WHEEL SET
CITY LIGHT**
BLACK: 517001016
WHITE: 517001018



**PRIAM FRONT WHEEL SET
TREKKING/ALL TERRAIN**
BLACK: 517001012
WHITE: 517001014

PARASOL

The adjustable parasol can be attached to the frame and offers the child UPF50+ protection.



515404008

INSECT NET

Optimal protection against insects. Thanks to the elastic material, it fits the PRIAM and MIOS perfectly.



515404006

CUP HOLDER

The cup holder can be easily attached to either side of the PRIAM and MIOS handle bar.



515404010

SNACK TRAY

A comfortable way for parents to transport and serve snacks while travelling with the kids.



PRIAM SNACK TRAY

517001674

MIOS SNACK TRAY

517001676

PRIAM KID BOARD

The Kid Board is a cool accessory perfect for older children. Easy to attach and fold away when not needed.



515215308

PRIAM SKIS

With the ski attachment to replace the front wheels, the PRIAM is transformed into a stylish snowmobile.



515404012

SUMMER COVERS

Made of 85% cotton and 15% polyester. Keeps the child comfortable and cool.



ATON Q
514409002



CLOUD Q
515409006



SOLUTION Q3-FIX
514409004



SIRONA
513408002
SIRONA Q I-SIZE
517002246

RAIN COVER

Wind and weather protection for all CYBEX infant car seats.



ATON Q
ATON Q I-SIZE
CLOUD Q
516404002

INSECT NET

Optimal protection against insects. Thanks to the elastic material, it fits all CYBEX infant car seats.



ATON Q
ATON Q I-SIZE
CLOUD Q
516405002

NEWBORN INLAY

The newborn inlay offers protection and comfort for the smallest of babies.



SIRONA
GREY: 515402006
BLACK: 515402004

FOOTMUFF Q

Cosy fleece lining for extra comfort and magnet clips for easy opening.



ATON Q
ATON Q I-SIZE
CLOUD Q
GREY: 515401012
BLACK: 515401018

SIRONA LOAD LEG EXTENSION

For some vehicle models, the Sirona can only be used with a load leg extension. For more information please see online or contact your local retailer.



513402015

BASE

Easy and safe installation with just one click without complicated installation using the seat belt.



BASE Q-FIX
515141002
BASE Q I-SIZE
516410002

ISOFIX GUIDES

Makes the car seat installation easier while protecting fabric and leather seating. A set is included with each CYBEX ISOFIX (Connect) car seat.



50054002

FIXING BELT

The headrest of the back seat and the car seat can be connected with the fixing belt, thus preventing any movement.



511410002







CYBEX GMBH | RIEDINGERSTR. 18 | 95448 BAYREUTH | GERMANY
CYBEX-ONLINE.COM