

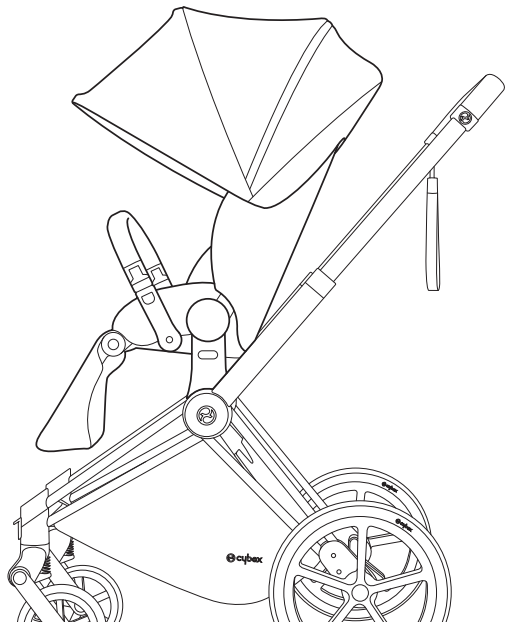

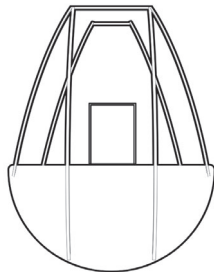

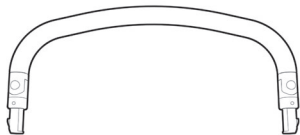

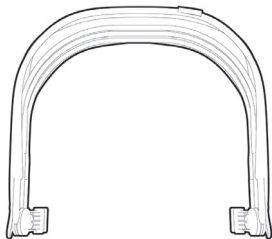

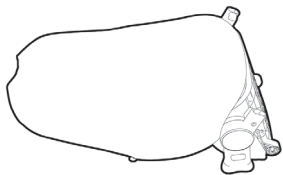























# PRIAM LUX SEAT















	Preparing the Lux Seat	8
	Self Standing	10
	Folding the Lux Seat	12
	Using the bumper bar	14
	Using the harness system	15
	Using the XXL sun canopy	18
	Adjusting the backrest	19
	Adjusting the footrest	20
	Using the rain cover	21
	Removing the Lux Seat cover	22

	Vorbereitung Lux Sitz	8
	Selbststehende Position	10
	Zusammenfallen des Lux Sitzes	12
	Verwendung des Schutzbügels	14
	Verwendung des Gurtsystems	15
	Verwendung des XXL Sonnendachs	18
	Einstellen der Rückenlehne	19
	Einstellen der Fußstütze	20
	Verwendung des Regenverdecks	21
	Abnehmen des Sitzbezuges	22

	Préparation du Siège Luxe	8
	Position debout	10
	Pliage du Siège Luxe	12
	Utilisation du garde-corps	14
	Utilisation du harnais	15
	Utilisation du canopy pare-soleil XXL	18
	Réglage du dossier	19
	Réglage du repose-pieds	20
	Utilisation de l'habillage pluie	21
	Retirer la housse du Siège Luxe	22

	Preparar el Lux Seat	8
	Posición de pie libre	10
	Plegado del Lux Seat	12
	Uso de la barra apoyabrazos	14
	Uso del sistema de arneses	15
	Uso de la capota XXL	18
	Ajuste del respaldo	19
	Ajuste del reposapiés	20
	Uso de la burbuja de lluvia	21
	Retirar la vestidura del Lux Seat	22

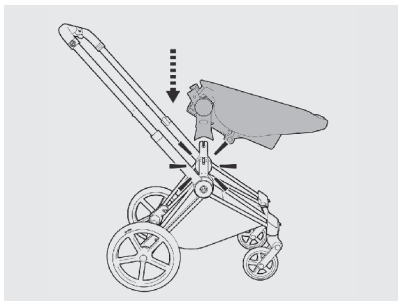

1



2

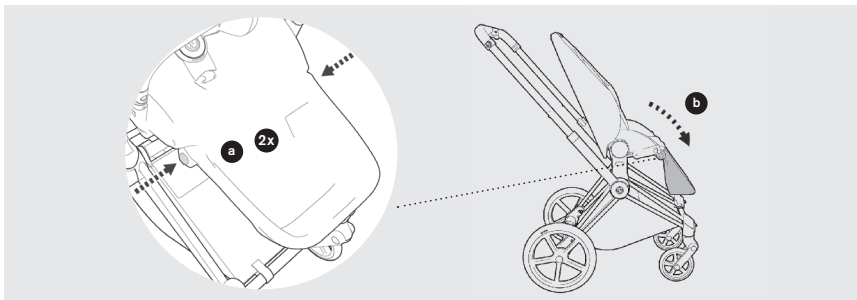

3

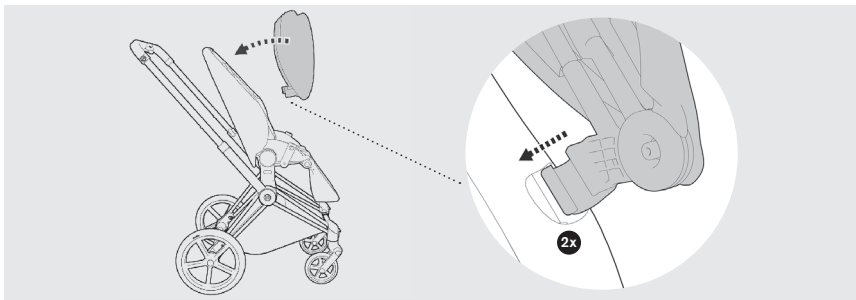

4

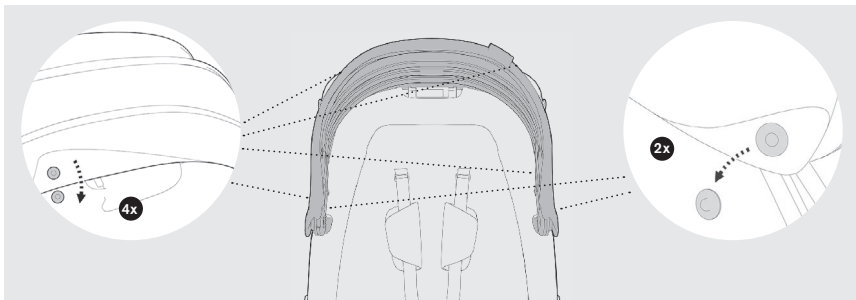

5



1



2

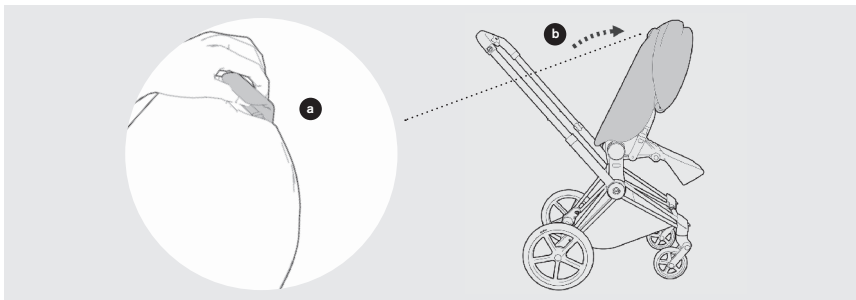

10

3

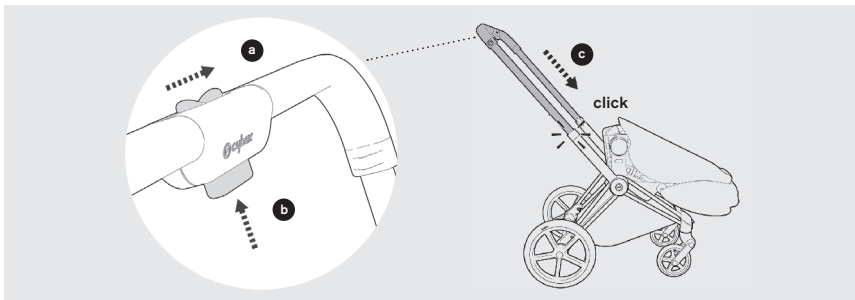

4

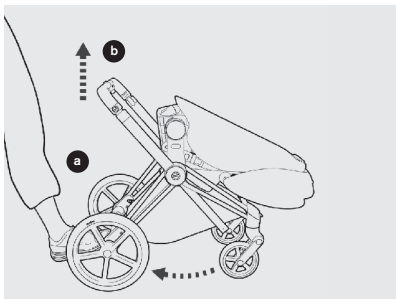

5

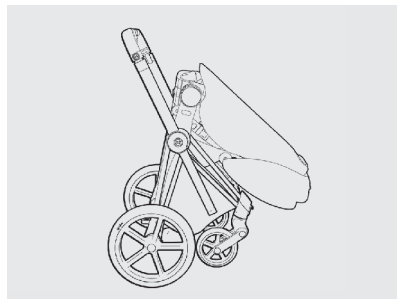

6



11

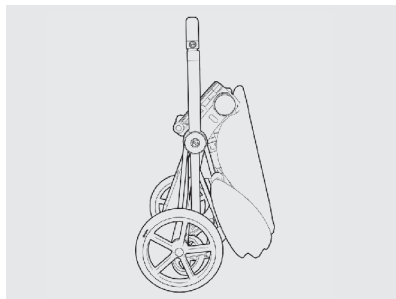
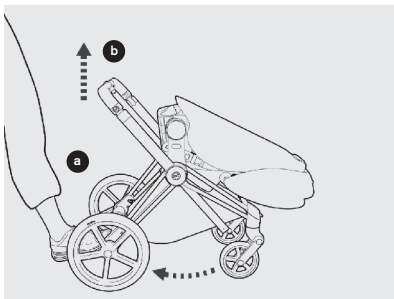
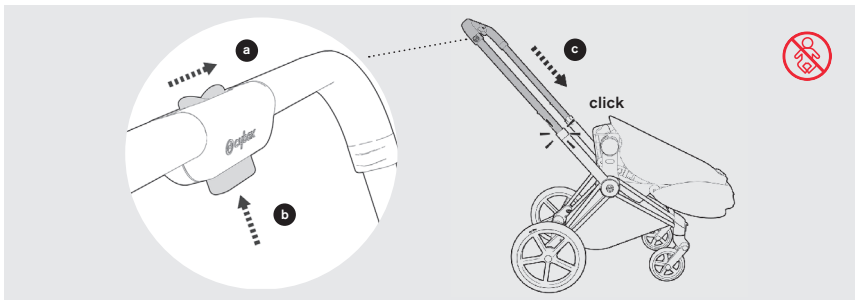

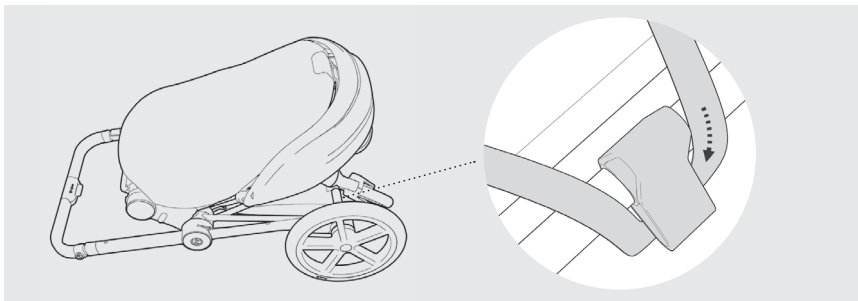

4

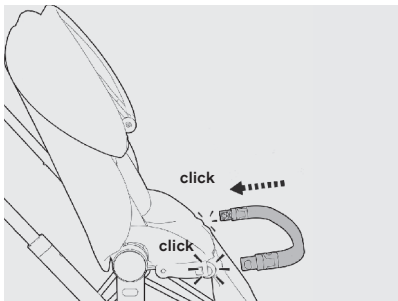

1

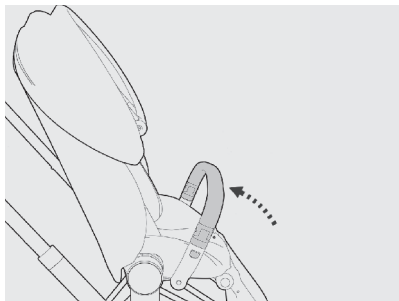

2

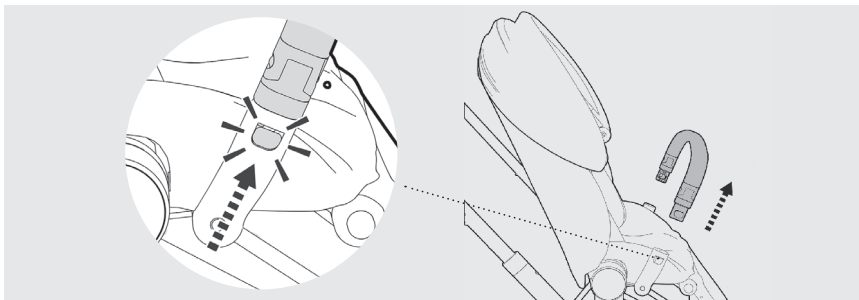

3

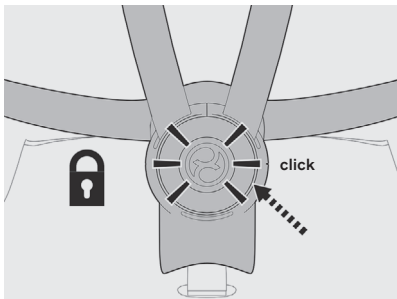

1

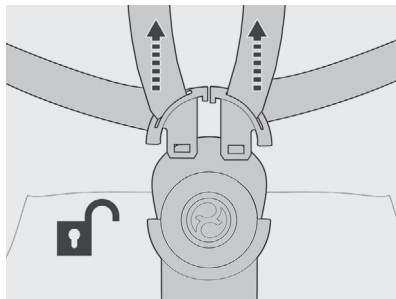

2

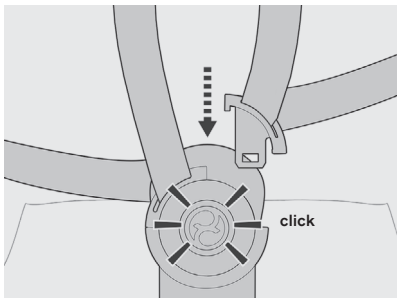

3

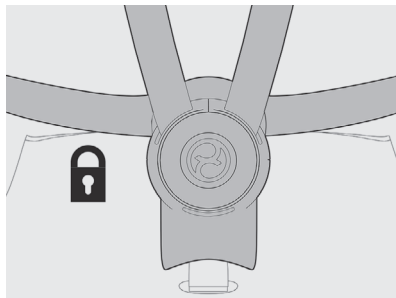

4



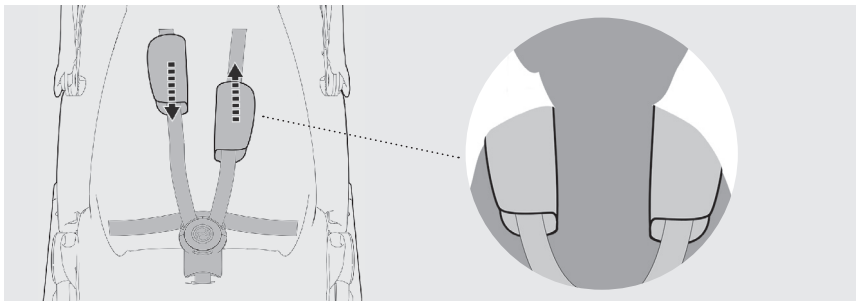

5

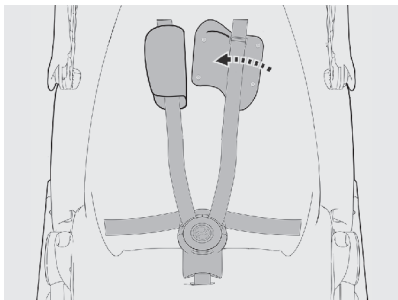

6

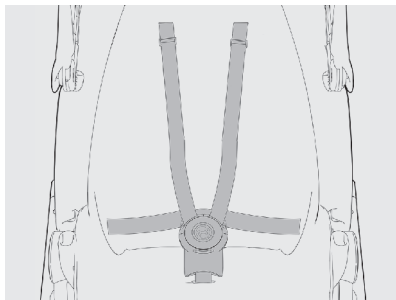

7

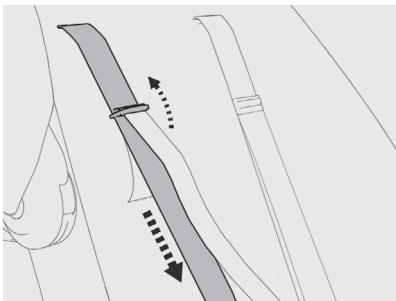

8

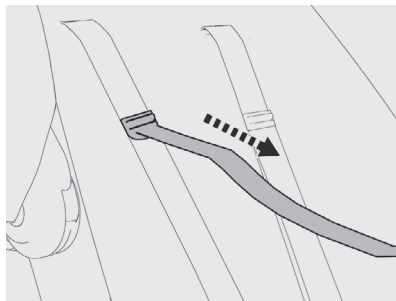

9



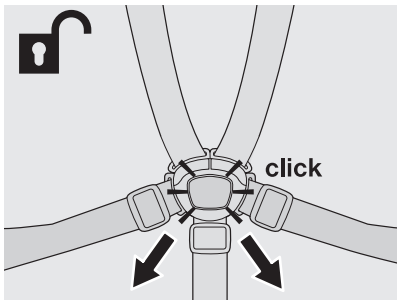

1

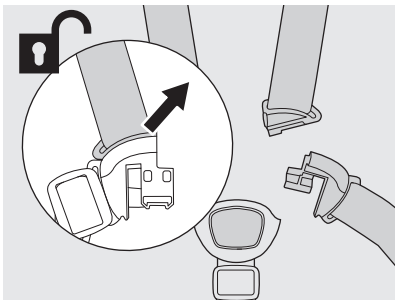

2

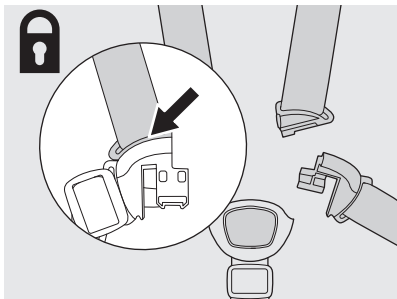

3

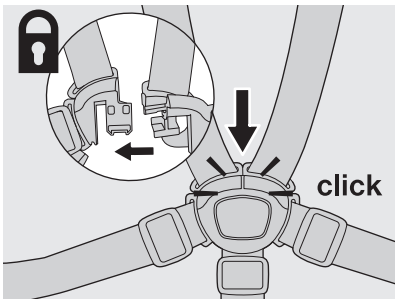

4

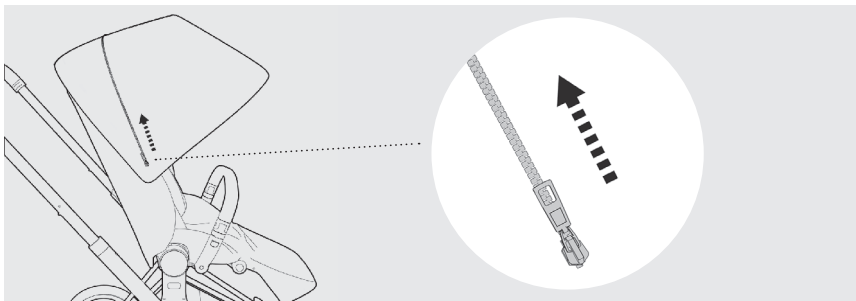

1

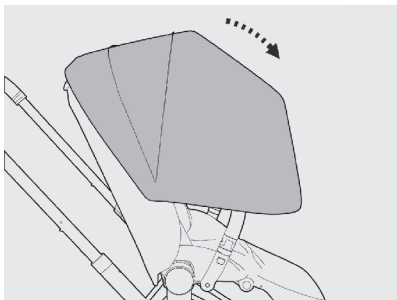

2

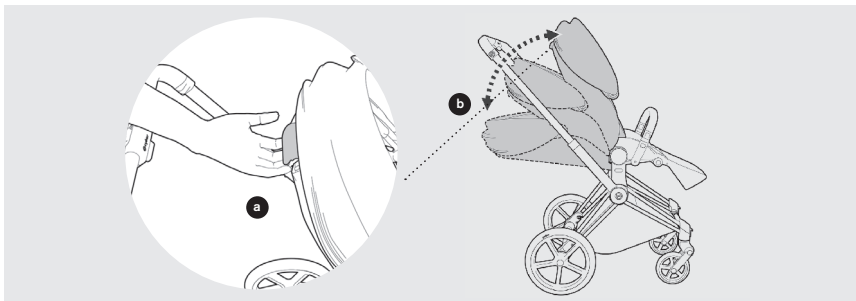

1

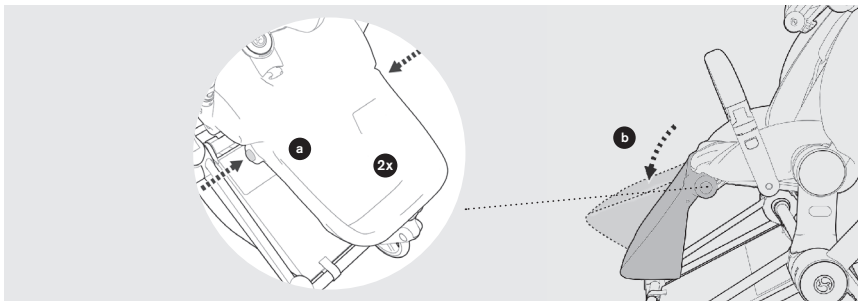

1

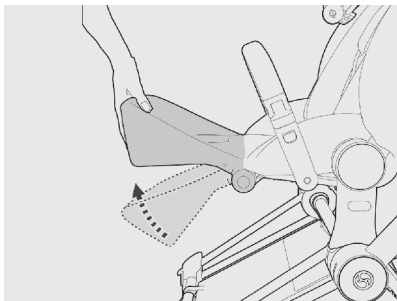

2

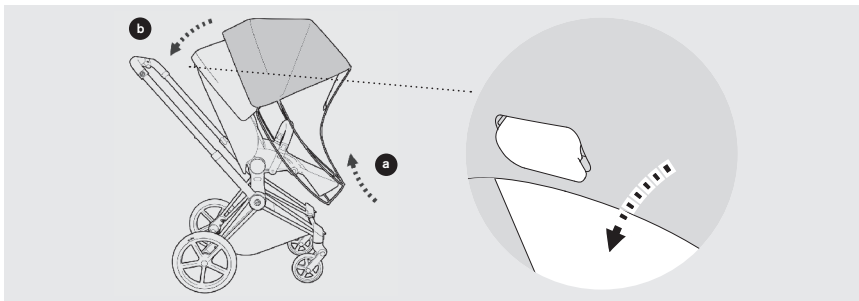

1

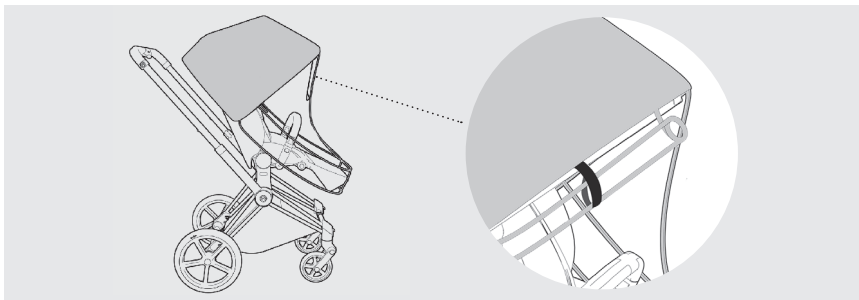

2



1

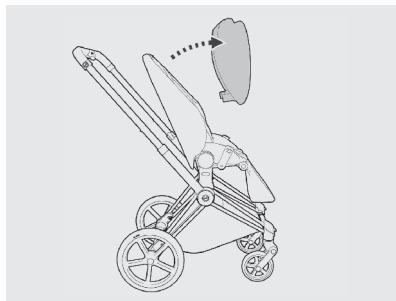

2

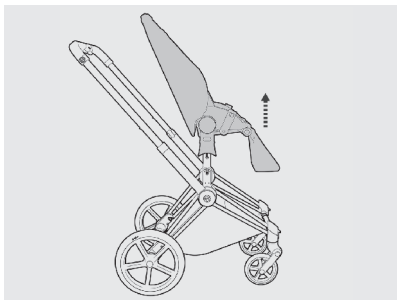

3

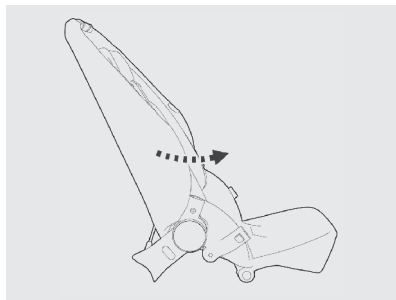

4



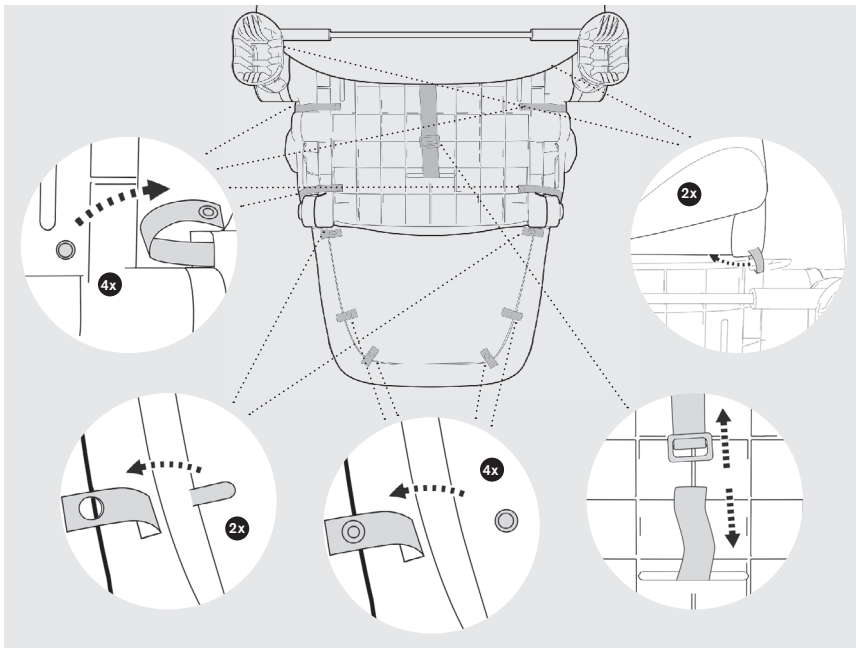

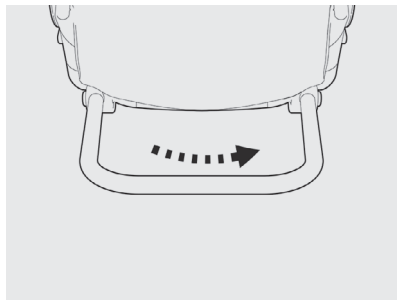
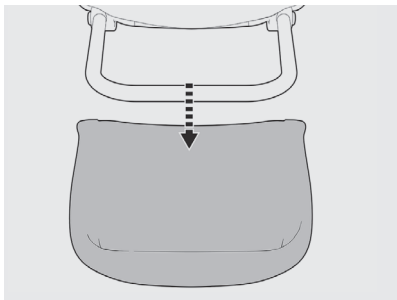
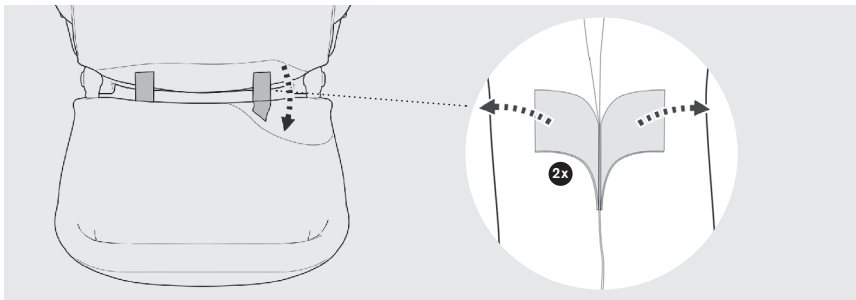

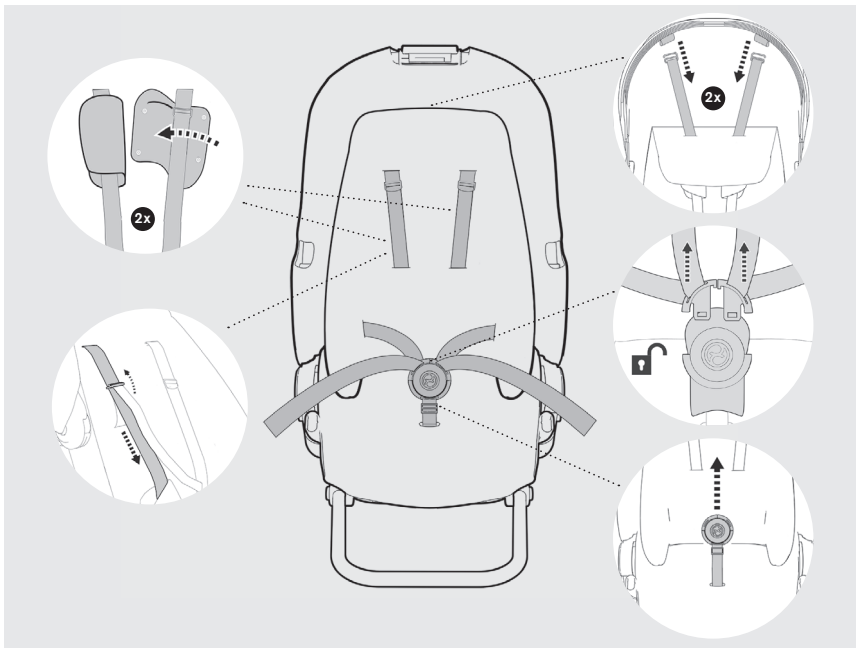

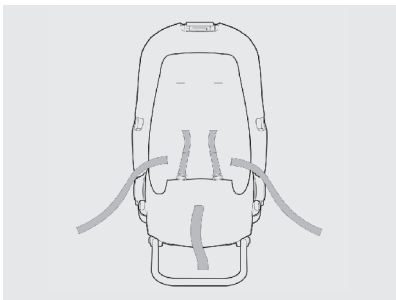

10

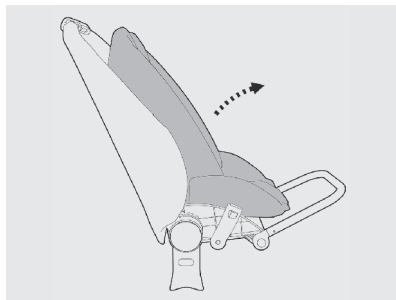

11

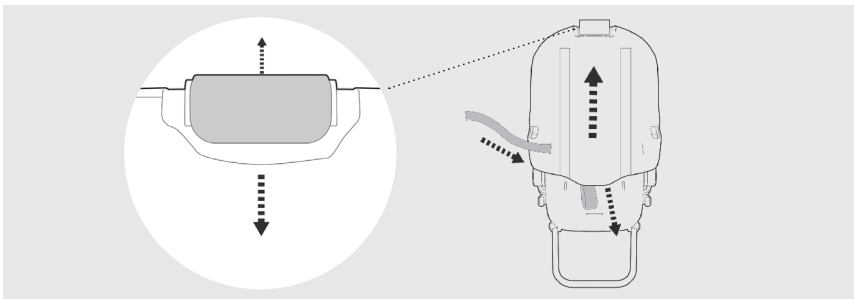

12

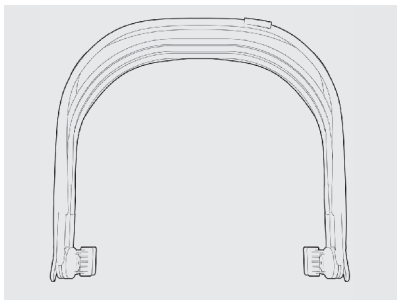

13

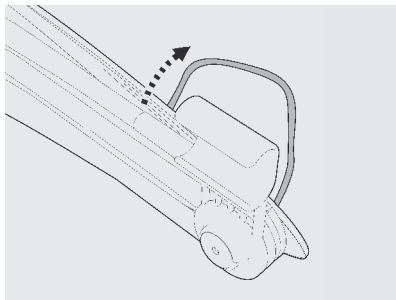

14

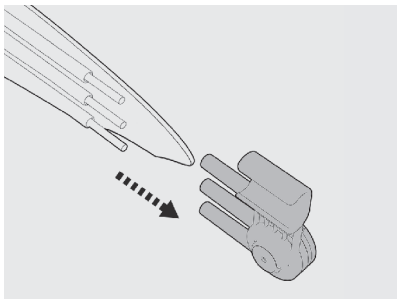

15

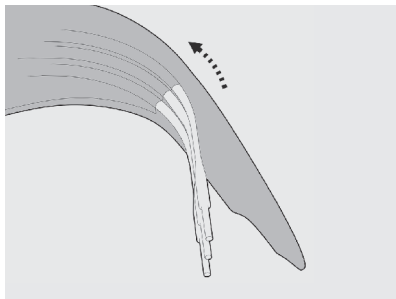

16

## CONTACT

### Europe

CYBEX GmbH  
Riedingerstr. 18  
95448 Bayreuth  
Germany  
+49 (0) 921-78 511 - 0  
info@cybex-online.com

### Americas

Columbus Trading-Partners USA Inc.  
560 Harrison Avenue, Suite 500  
Boston, MA 02118, USA  
Customer Service 1-877-242-5676  
orders.us@columbustp.com

### Japan

Cybex Industrial Ltd.  
Room 2001, 20/F  
Two Chinachem Exchange Square  
338 King's Road, North Point, Hong Kong  
+81 30 5456 5225  
info@cybex-japan.com

### Australia

CNP Brands  
20 Calarco Drive, VIC, 3030  
Australia  
Customer Service 1300 667 137  
info@cnppbrands.com.au

### New Zealand

Wainhouse Distribution,  
2-6 Argyle St, Morningside, PO Box 41-014,  
St Lukes, Auckland, New Zealand  
Customer Service 0800 567 5000  
helpline@wainhousedist.co.nz



[www.cybex-online.com](http://www.cybex-online.com)